

# OPERATORS' GUIDE

## REL-46

15 TON SINGLE ACTING  
REMOTE HYDRAULIC  
CRIMPING HEAD



Compatible with **RELIABLE**  
R15 and "P" Style dies.

### WARNING



All information found in this guide must be read and understood before use or testing of this tool.

Failure to read and understand these warnings and safe handling instructions could result in severe personal injury and or death.

#### RELIABLE EQUIPMENT & SERVICE CO., INC.

92 Steamwhistle Drive • Ivyland, PA 18974 • USA  
Phone: 215-357-3500 • Fax: 215-357-9193

MODEL: \_\_\_\_\_

MAX. PRESSURE: \_\_\_\_\_

SERIAL NO.: \_\_\_\_\_

YEAR: \_\_\_\_\_

### NOTICE

Sizes, weights and tool specifications listed in this manual are subject to change without notice. Please consult factory for information and updates.

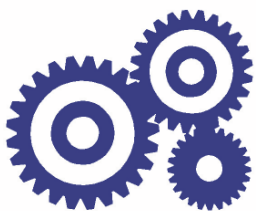

# RELIABLE EQUIPMENT & SERVICE CO., INC.

# DISTRIBUTED BY

## REGISTRATION

UPON RECEIPT OF THIS TOOL, COMPLETE THE REGISTRATION BELOW.

COMPANY \_\_\_\_\_

ADDRESS \_\_\_\_\_

\_\_\_\_\_

PHONE \_\_\_\_\_ FAX \_\_\_\_\_

SERIAL NUMBER \_\_\_\_\_

DATE OF PURCHASE \_\_\_\_\_

DEALER NAME \_\_\_\_\_



CAUTION

The information in this manual is intended to guide the user in the use and application of this tool. It is not intended as a substitute for proper training and experience in safe work practices for this type of equipment.

Consult your supervisor or safety personnel if you have any questions regarding the safe operation of this tool.

# TABLE OF CONTENTS

<b>DISTRIBUTOR INFORMATION .....</b>	<b>2</b>
<b>REGISTRATION .....</b>	<b>2</b>
<b>TABLE OF CONTENTS .....</b>	<b>3</b>
<b>TOOL SPECIFICATIONS</b>	
<b>REL-46 - MANUAL HYDRAULIC</b>	
<b>15 TON COMPRESSION TOOL .....</b>	<b>4</b>
<b>SAFETY INFORMATION AND WARNINGS .....</b>	<b>5-9</b>
<b>OPERATING INSTRUCTIONS .....</b>	<b>10</b>
<b>DAILY MAINTENANCE .....</b>	<b>11</b>
<b>GENERAL MAINTENANCE .....</b>	<b>11</b>
<b>LABEL SET .....</b>	<b>12</b>
<b>PARTS LIST .....</b>	<b>12</b>
<b>PARTS DRAWING .....</b>	<b>13</b>
<b>MAINTENANCE RECORDS .....</b>	<b>14</b>
<b>CONTACT INFORMATION .....</b>	<b>14</b>

If you have any questions regarding the information found in this manual please contact RELIABLE EQUIPMENT at 800-966-3530 or FAX 215-357-9193.



**THIS SYMBOL INDICATES ITEMS OF EXTREME IMPORTANCE.**

Safety of user and others may be in jeopardy if these instructions are not read and understood.

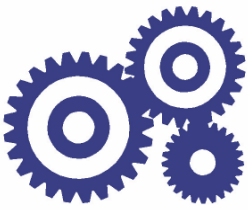

# RELIABLE EQUIPMENT & SERVICE CO., INC.

## REL-46



Compatible with RELIABLE R15 and "P" Style dies.

## 15 TON SINGLE ACTING HYDRAULIC CRIMPING TOOL



The **REL-46** Single Acting Hydraulic 15 ton Crimping Head. Easy, one-hand operation, and 360 ° rotating head allows easy head orientation for precision control of crimping to improve safety and reliability.

Accepts R15 and "P" style dies to crimp connector sizes up to 1,250 MCM-CU. With an optional PU adaptor this tool will accept Reliable R12 or "U" style dies as well as some dies from Alcoa, Burndy, Thomas & Betts, and Blackburn.

### SPECIFICATIONS

System	Single-Acting
Jaw Capacity	2 inch
Crimping Force	24,300 lb.
Oper. Pressure	10,000 psi (690 bar)
Couplers	3/8 inch Female
Dies Accepted	Y-46 or Equal
W/ PU Adaptor	Y-35 or Equal
Head Rotation	360°

**Weight:** 10 lbs.  
**Length:** 10.5 inches  
**Width:** 6 inches



## RELIABLE EQUIPMENT & SERVICE CO., INC.

92 Steamwhistle Drive • Ivyland, PA 18974  
Phone: 800-966-3530 • Fax: 215-357-9193  
Visit us on the web at [www.Reliable-Equip.com](http://www.Reliable-Equip.com)



**WARNING**

**BEFORE USING THIS TOOL, READ THE WARNINGS and the recommended practices described in this manual. Failure by the operator to read and fully understand these warnings will leave this person unqualified to use and operate this tool. Property damage, severe personal injury, and/or death could result by not following these warnings.**

These warnings will appear in appropriate locations when they are pertinent to the particular subject being shown. Read each one carefully and follow them strictly.



### **Eye Protection**

**WARNING**

**Always wear eye protection to avoid injury from flying debris or hydraulic oil leaks. Failure to do so can result in serious personal injury.**



### **Skin Irritation**

**WARNING**

**Hydraulic oil may cause irritation. Use care to prevent contact with skin. In case of accidental contact, wash affected area immediately**



### **Hard Hat**

**WARNING**

**Always wear a hard hat to avoid injury from falling debris. Failure to do so can result in serious personal injury.**



### **Foot Protection**

**WARNING**

**Always wear foot protection. Failure to do so can result in serious personal injury.**



### **Hearing Protection**

**WARNING**

**Always wear hearing protection, to avoid hearing loss due to long term exposure to high noise levels.**



### **Protective Gloves**

**WARNING**

**Always wear protective gloves Failure to do so can result in serious personal injury.**



WARNING

## SAFE OPERATION & CARE

**USE THIS TOOL FOR ITS INTENDED PURPOSE ONLY**  
Any other use can result in personal injury or property damage.

**INSPECT TOOL BEFORE USE.** Replace any worn, damaged or missing parts. A damaged or improperly assembled tool may malfunction, injuring operator and/or nearby personnel.

**INSPECT HYDRAULIC HOSES AND COUPLINGS** before each use. Repair or replace if any cracking, leakage, wear or damage is found. Worn or damaged hoses may fail resulting in personal injury or property damage.

**CLEAR WORK AREA** of all bystanders and unnecessary personnel before operating this tool.

**KEEP ALL PARTS OF THE BODY AWAY FROM MOVING PARTS.**

Failure to observe this warning could result in serious injury.



WARNING

## HYDRAULIC POWER SUPPLY

**DO NOT** attempt to make any changes to any of the component parts or accessories when connected to the power source.

**DO NOT** adjust, inspect, or clean tool while the tool is connected to the power source. The tool could accidentally start up and cause serious injury.

**DO NOT** lock the tool in the On Position. In an emergency, serious damage or injury could occur during the time required to stop the tool.



WARNING

## OIL INJECTION INJURY

Hydraulic oil or fluid under the skin is a serious injury. Oil under pressure can penetrate the skin and may cause dismemberment or loss of life. Seek medical assistance immediately if such an injury should occur.

Always wear safety gloves, eye protection and all required safety equipment when operating or handling this tool.

**DO NOT** use fingers or hands to attempt to locate a leak.

**DO NOT** handle hoses or couplers while system is pressurized.

**NEVER** open or service the system before depressurizing.



WARNING

## HOSES AND FITTINGS

There exists the potential for shock in using anything other than certified nonconductive hoses and hydraulic oil with dielectric properties, when using system components near energized electrical lines. Failure to recognize these conditions could cause electrocution.

Hoses and fittings used with this tool must comply with S.A.E. J1273 which covers recommended practice for selection, installation, and maintenance of hose and hose assemblies. The **correct hoses and fittings are available from your supplier.**

**WARNING:** Failure to comply with these warnings could result in severe bodily injury.



WARNING

## UNIT/HOSE CONNECTIONS

**ALWAYS DISCONNECT** pump/power source and move toggle switch to **OFF** before connecting or disconnecting any components.

**ALWAYS DEPRESSURIZE** hydraulic system, before slowly disconnecting this unit or any of the systems components.

**ALWAYS TIGHTEN** couplings completely. Loose or improperly tightened couplings will not allow fluid to pass through the hose creating a blockage in the supply or return line.

**ALWAYS INSPECT HOSES AND CONNECTORS** before connection to tool. Replace or repair if any leakage is evident. Leakage is a sign of deterioration in component parts. Worn or leaking parts must be repaired or replaced, or tool damage or severe injury could result.



WARNING

Operation/Safety methods may vary in accordance with the working guidelines established by each utility or contractor.

For your own safety, ensure that you fully comply with all safe operation guidelines required by your employer.



WARNING

## ELECTRICAL SHOCK HAZARD

Always wear and use the necessary clothing, equipment and safety practices to protect against electrical shock. Failure to follow these rules can result in serious personal injury or death.



**WARNING**

## **SERIOUS BURN HAZARD**

**HOT SURFACES MAY CAUSE SERIOUS BURNS.**

The hydraulic cylinder may be hot during and after operation.

**CAUTION: HYDRAULIC FLUID MAY CAUSE SERIOUS BURNS.**

Never disconnect tool, hoses, or fittings while the hydraulic power source is running or if the hydraulic fluid is hot.

Failure to observe this warning could result in serious injury.



**WARNING**

## **CRIMP DANGER**

This hydraulic crimping tool can crush and/or disable.

**KEEP ALL PARTS OF THE BODY AWAY FROM MOVING PARTS.**

**DO NOT** lock the tool in the On Position. In an emergency, serious damage or injury could occur during the time required to stop the tool.

Failure to observe this warning could result in serious injury



**WARNING**

## **TOOL HAZARD**

**DO NOT OPERATE TOOL WITHOUT DIES.**

**DO NOT EXCEED THE MAXIMUM HYDRAULIC FLOW, RELIEF PRESSURE, OR BACK PRESSURE.**

Failure to observe warnings could result in tool damage or injury.



**WARNING**

## **FIRE HAZARD**

An incomplete crimp may pose a fire hazard.

Always use the appropriate connector, die set, and compression tool, as required by the intended application.

Compression tool should be tested on a regular schedule to ensure accurate compression.

Failure to observe this warning could result in serious injury.

**IF YOU HAVE ANY QUESTIONS REGARDING THE SAFE USE AND/OR OPERATION OF THIS TOOL, CONSULT YOUR AREA SUPERVISOR, OR CONTACT RELIABLE EQUIPMENT AT 800-966-3530**

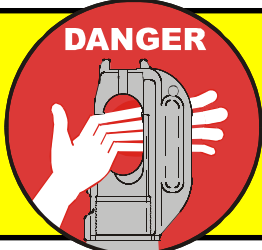
 **DANGER**

**THIS TOOL CAN CAUSE SEVERE INJURY**  
JAW CLOSSES QUICKLY & WITH EXTREME FORCE  
KEEP ALL BODY PARTS OUTSIDE DANGER ZONE

 **GENERAL SAFETY** 

**USE ALL APPROPRIATE AND APPLICABLE PERSONAL SAFETY EQUIPMENT** as required by the operating company.

**INSPECT TOOL BEFORE USE.** Replace any worn, damaged or missing parts. A damaged or improperly assembled tool may injure operator and/or nearby personnel.

**KEEP ALL PARTS OF THE BODY AWAY** from moving parts of the tool.

**ALL BODY PARTS SHOULD BE OUTSIDE DANGER ZONE PRIOR TO COMPRESSION.**

**MAKE SURE** there is no person in close proximity to you or the tool who could be injured by any operation being performed, tool malfunction or flying debris.

**DO NOT OVEREXTEND** your position by overreaching or unbalancing the footing necessary to maintain physical control of your body and the tool.

**ALWAYS MAINTAIN** a firm grip on the tool to avoid loss of control during an operation, causing property damage, serious injury or death.

**USE THIS TOOL FOR THE MANUFACTURERS' INTENDED PURPOSE ONLY.**

**OBSERVE CLOSELY ALL OF THE SAFETY RULES FOR A PARTICULAR JOB CLASS**

Operation/Safety methods may vary in accordance with the working guidelines established by each utility or contractor. Ensure that you fully comply with all safe operation guidelines required by your employer.

**FAILURE TO HEED SAFETY WARNINGS MAY RESULT IN PROPERTY DAMAGE, SERIOUS INJURY OR DEATH**

 **WARNING**

Inspection & Testing requirements may vary in accordance with the working guidelines established by each utility or contractor. For your own safety, ensure that you fully comply with all safe operation guidelines required by your employer.

**IF YOU HAVE ANY QUESTIONS REGARDING THE PROPER USE AND/OR OPERATION OF THIS TOOL, CONSULT YOUR AREA SUPERVISOR, OR CONTACT RELIABLE EQUIPMENT AT 800-966-3530**

# OPERATION

Read entire manual prior to using this tool. (Refer to all safety recommendations and warnings) Observe all safety precautions and procedures required by the operating company. (Also refer to SAFETY information found on pages 5 through 9)

Before crimping, ensure that crimp is within the capacity listed for the tool.

Refer to connector manufacturer's instructions for cable preparation and crimping procedure. Ensure that you are using the proper die, as recommended by the connector manufacturer.

## **WARNING: DO NOT OPERATE TOOL WITHOUT COMPRESSION DIES**

1. Ensure that proper 10,000 psi power source is turned **OFF** and valve is in **OFF** position.
2. Connect to a 10,000 PSI power source with audible "Pop Off" type relief valve. (Recommended) Refer to page 7 UNIT/HOSE CONNECTION
3. Ensure that the ram is fully retracted.
4. Insert proper die into die seat.

## DIE INSTALLATION

This tool uses R15 and "P" type 15 ton dies. With an optional PU Adaptor this tool will accept standard R12 and "U" style 12 ton dies.



Press die retainer button and slide "P" type die onto die retainer.

Ensure that die is secure.



Press button on adapter and slide "U" die under retaining lip.

Ensure that die is secure.



Press die retainer button and slide PU Adapter onto die retainer.

Ensure that die is secure.



Ensure that you are using the proper die, as recommended by the connector manufacturer.

5. Place tool over connector. Center connector between the dies.
6. Align jaw as necessary to ensure proper crimp. Position subject at a 90° angle to the tool.

## **KEEP HANDS AND ALL BODY PARTS AWAY FROM COMPRESSION OPERATION**

7. Turn power source "ON" and activate control valve to advance compression dies up to subject. **Check tool alignment.**
8. Continue to advance until "pop off" is felt or heard and full pressure has been obtained.
9. Return source to the "OFF" position and allow ram to retract completely.
10. Repeat procedure as required by compression sleeve or regulating authority.
11. Visually inspect crimp for correctness.

# DAILY MAINTENANCE

**The life, reliability, and safety of the tool is dependent on proper use and maintenance.**

STORE THE TOOL PROPERLY . . . Before storing tools release pressure so that the crimping jaw fully retract. This protects the operating ram from moisture and condensation.

**NOTE:** When the tool has been stored for extended period of non-use, the tools should be activated approximately every 3 weeks to keep o-rings and seals lubricated. Clean and inspect all surfaces including head, ram, body and coupler.

**WARNING:** Head may cut or pinch. Please use extreme caution.

Worn or damaged parts may malfunction during operation, causing more extensive damage to the tool and/or severe injury to the operator or bystander.

**All parts must be replaced with new parts if signs of wear or damage are evident.**

---

DO NOT MAKE ADJUSTMENTS TO THE TOOL . . . There are no adjustments on this tool which can be made in the field. If a tool becomes inoperative and the instructions in this booklet do not correct the malfunction have the tool serviced by RELIABLE EQUIPMENT or an authorized service provider.

Keep Label Set clean and legible. Replace decals when necessary.

## GENERAL MAINTENANCE

Manufacturer recommends regular testing for proper pressure and operation.  
Test at least every 6 (six) months, test more often under heavy usage.

This tool requires well-trained experienced personnel for major repairs, adjustments or maintenance. **Complete disassembly is not recommended. Return the unit to an authorized dealer for total disassembly and/or repair.** It is suggested that tools requiring repairs be returned to Reliable Equipment for correction unless overall local conditions are adequate and service training has been provided. Reliable Equipment is set up to provide quick maintenance and overhaul service. Contact your Reliable Equipment representative if service is required.

All maintenance or disassembly should take place on a flat, clean work surface covered with towels or wipers so as to have a clean space for the disassembled parts.

Inspect each part during disassembly for wear, scratches, and cuts. Discard the worn or damaged parts and replace with new factory authorized parts.

O-rings are sensitive to sharp edges. Inspect closely for cuts or damage. A small cut will cause a leak. When assembling or disassembling O-rings, use hydraulic fluid as a lubricant to help disassembly or installation.

**NOTICE:** When disposing of hydraulic fluid, parts or components observe all federal, state, and local guidelines.

# REL-46 - REMOTE HEAD PARTS LIST

ITEM	QTY	PART #	DESCRIPTION
1	15050	1	CRADLE
2	K5054	1	DIE RETAINER KIT (2 PINS, 2 NUTS, 2 SPRINGS)
3	15004	1	HEAD ( SUPPLIED BY RELIABLE)
4	15101	1	LOWER HOUSING
5	15102	1	RAM
6	15125	1	EXTENSION SPRING ASSY
7	15013	1 *	WIPER
8	15014	2 *	O-RING
9	15015	2 *	BACKUP RING
10	15018	4	SCREW ( CRADLE )
	15199		SEAL KIT

\* ITEMS INCLUDED IN SEAL KIT

NOTE: Keep Label Set clean and legible. Replace decals when necessary.



**WARNING**

BEFORE USING THIS PRODUCT READ THE SAFETY WARNINGS and recommended practices described in the manual. Failure by the operator to read and fully understand the warnings will leave this person unqualified to use and operate the tool.

Failure to observe all warnings and instructions could result in property damage, severe personal injury, and/or death.



**WARNING**

KEEP BODY PARTS OUT OF COMPRESSION ZONE



**CAUTION**

Operation and safety methods may vary in accordance with the guidelines established by each utility. For your safety, ensure that you fully comply with all safe operation guidelines established by your respective power utility.

REL-SM



**CAUTION**

Do not operate without dies.

**IF YOU HAVE QUESTIONS REGARDING THE REPAIR AND MAINTENANCE OF THIS TOOL CONTACT RELIABLE EQUIPMENT OR YOUR RELIABLE EQUIPMENT REPRESENTATIVE.**

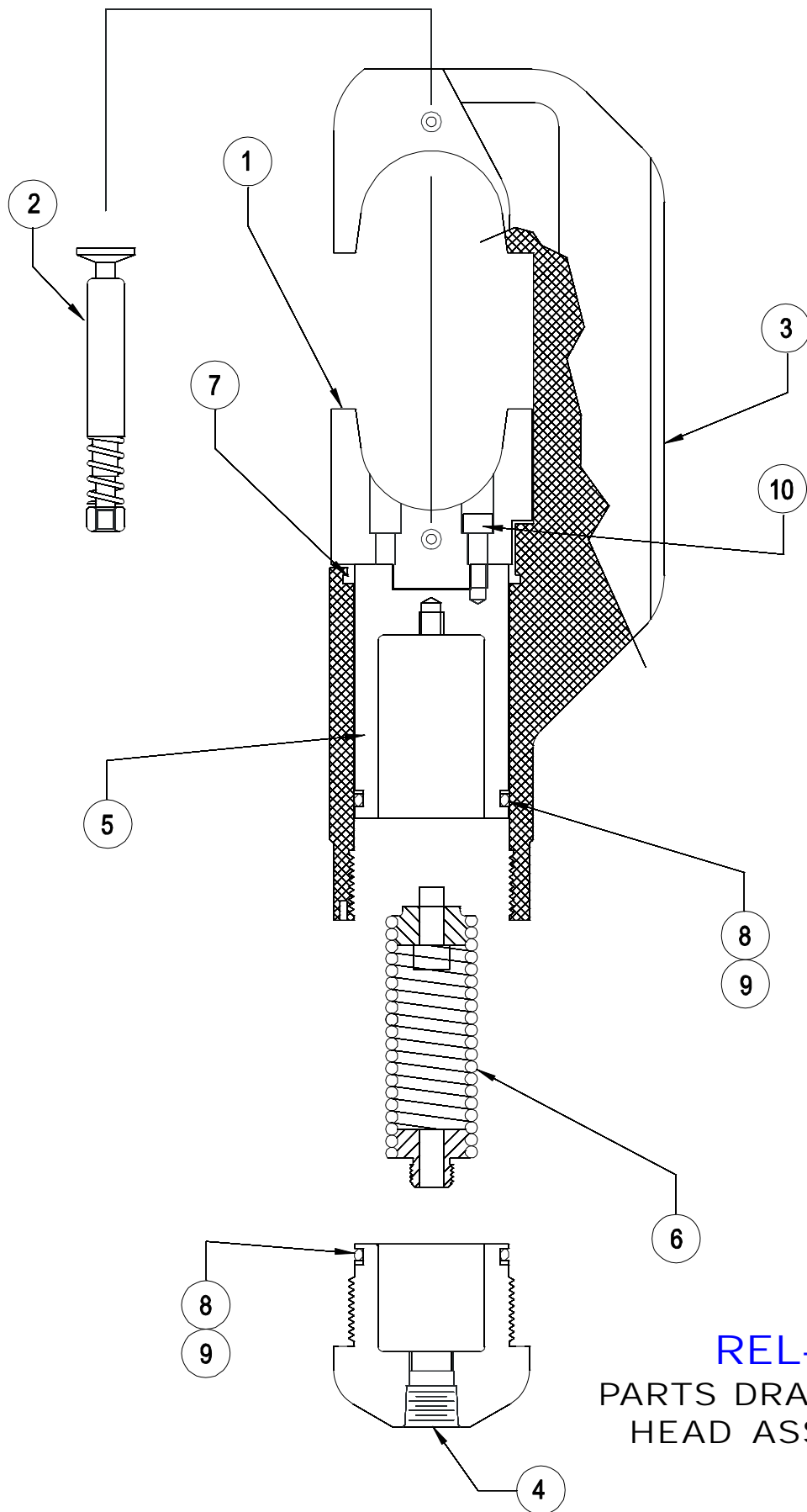

**REL-46**  
 PARTS DRAWING # 1  
 HEAD ASSEMBLY

